

PHSOTEY - prosessikartta

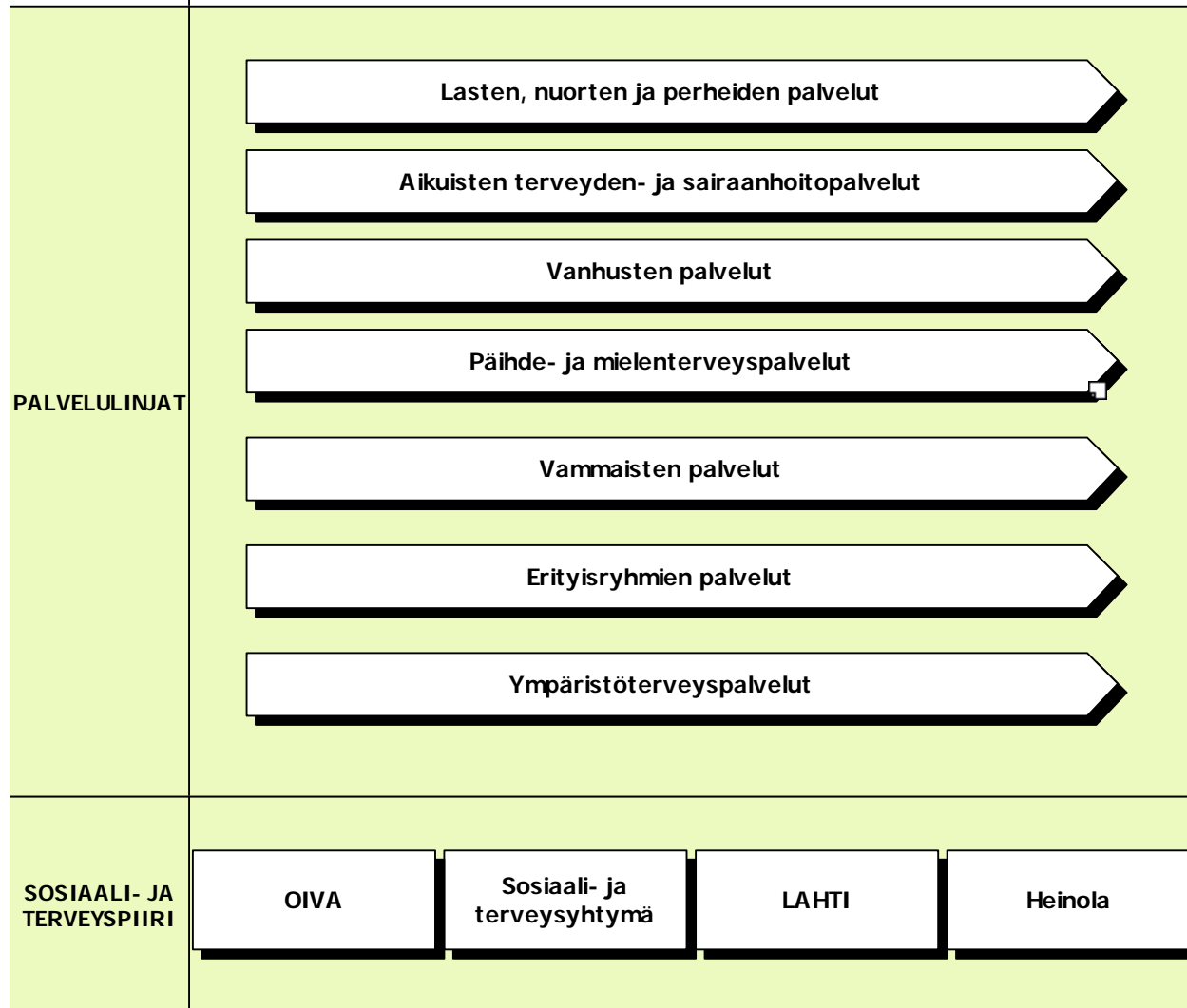

Palvelukokonaisuudet

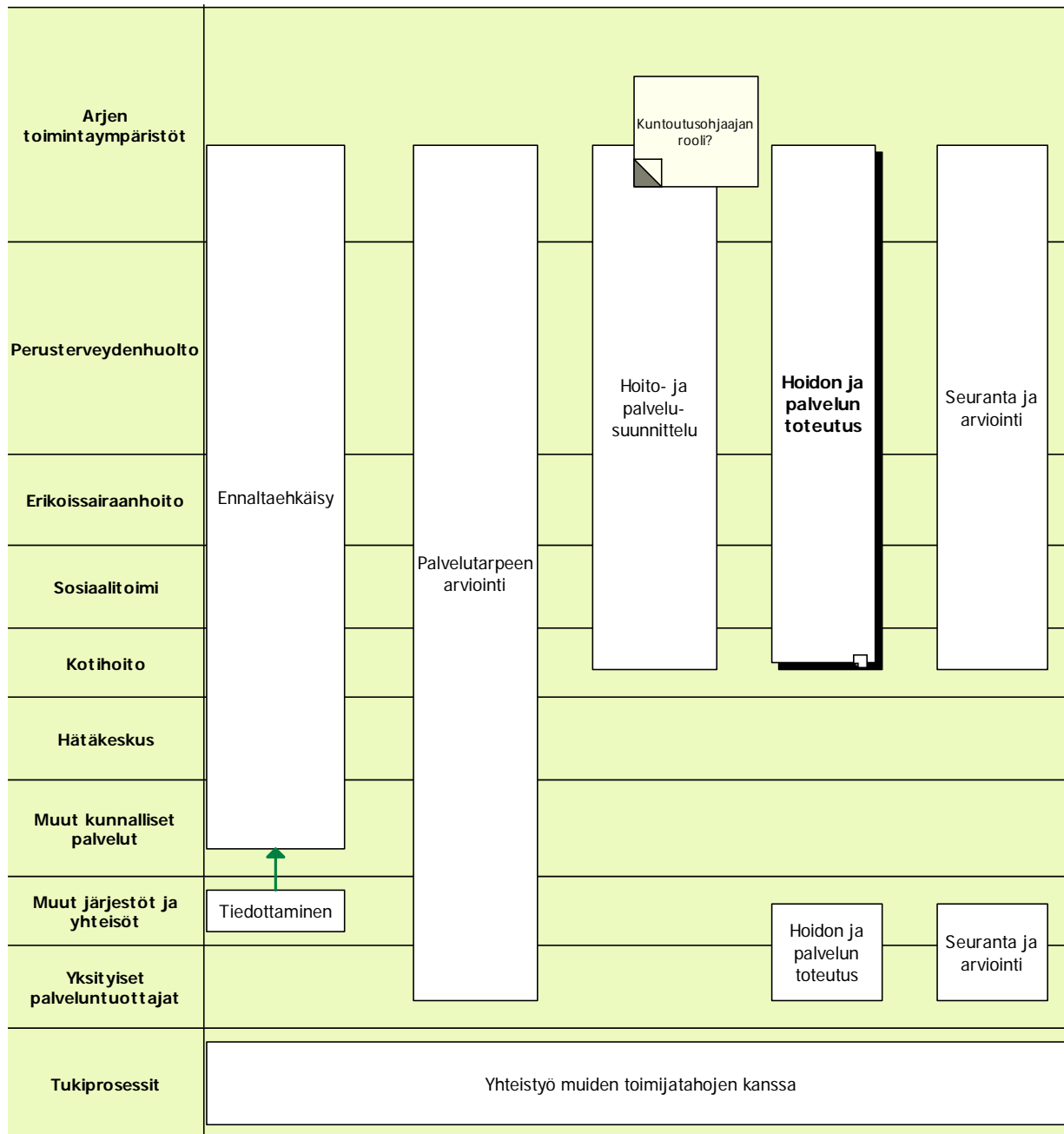



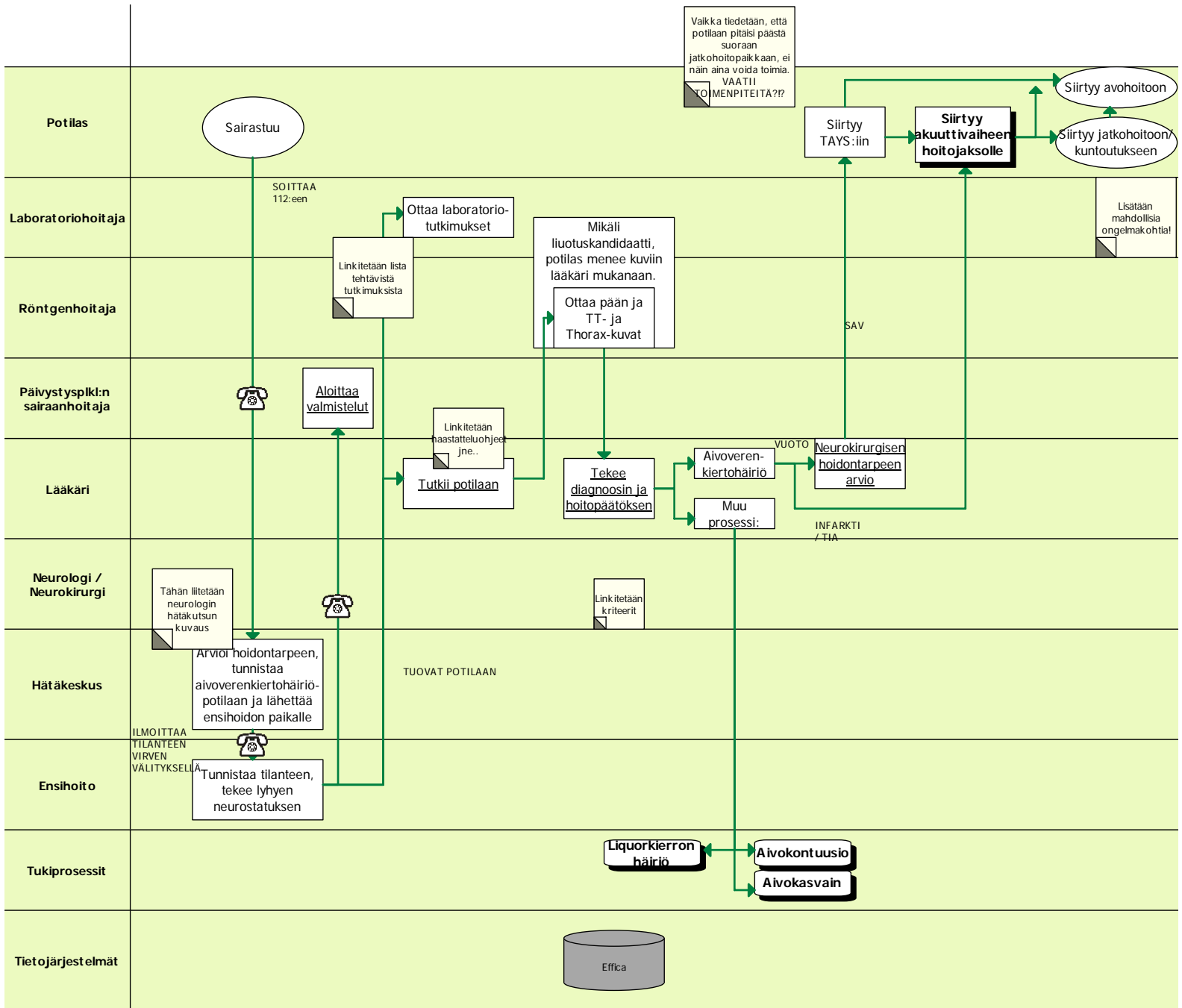

Ei suljeta pois
lapsia ja nuoria

Päihdeongelmaiset

Moniongelmaiset

Mielenterveysongelmaiset

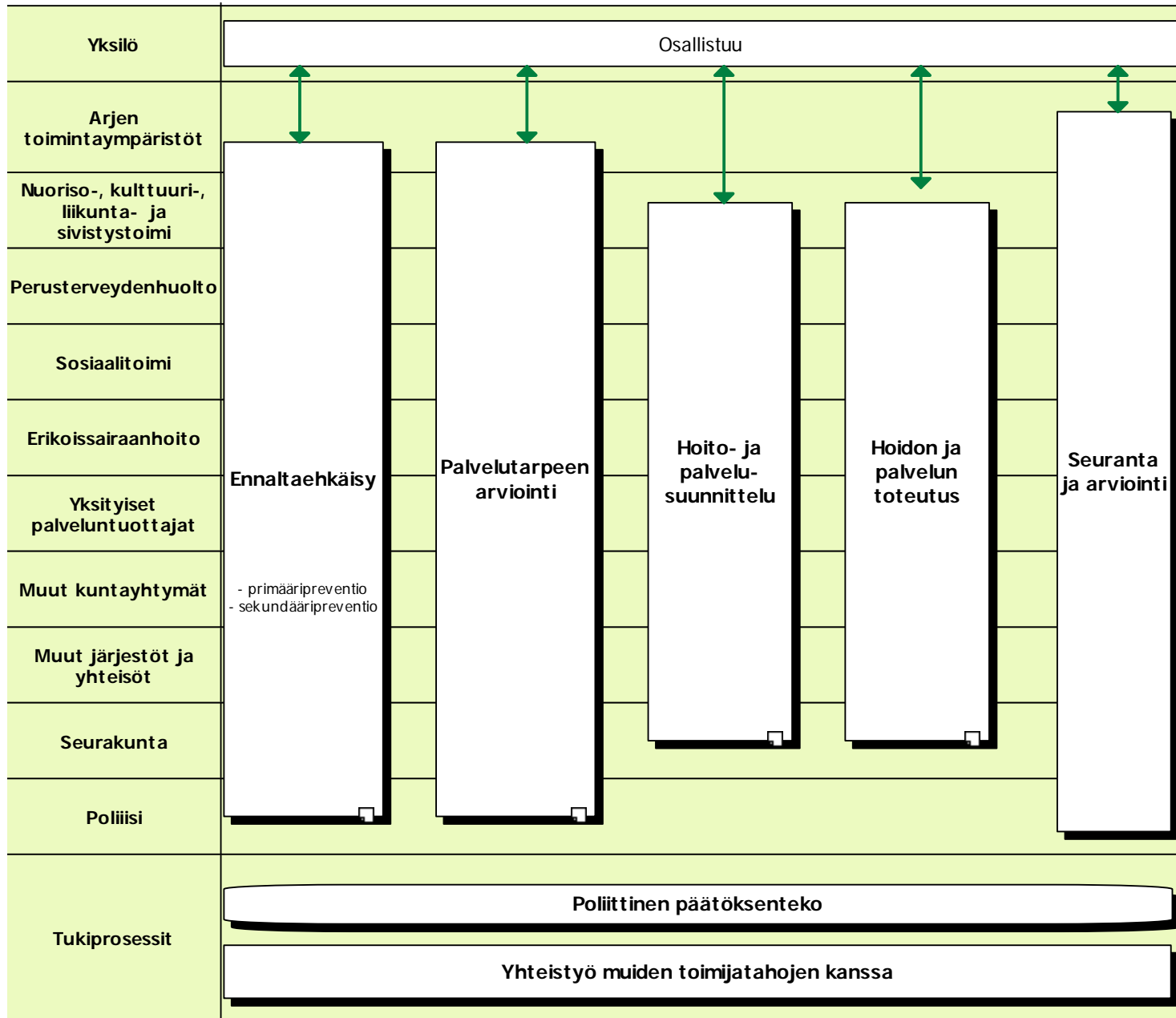

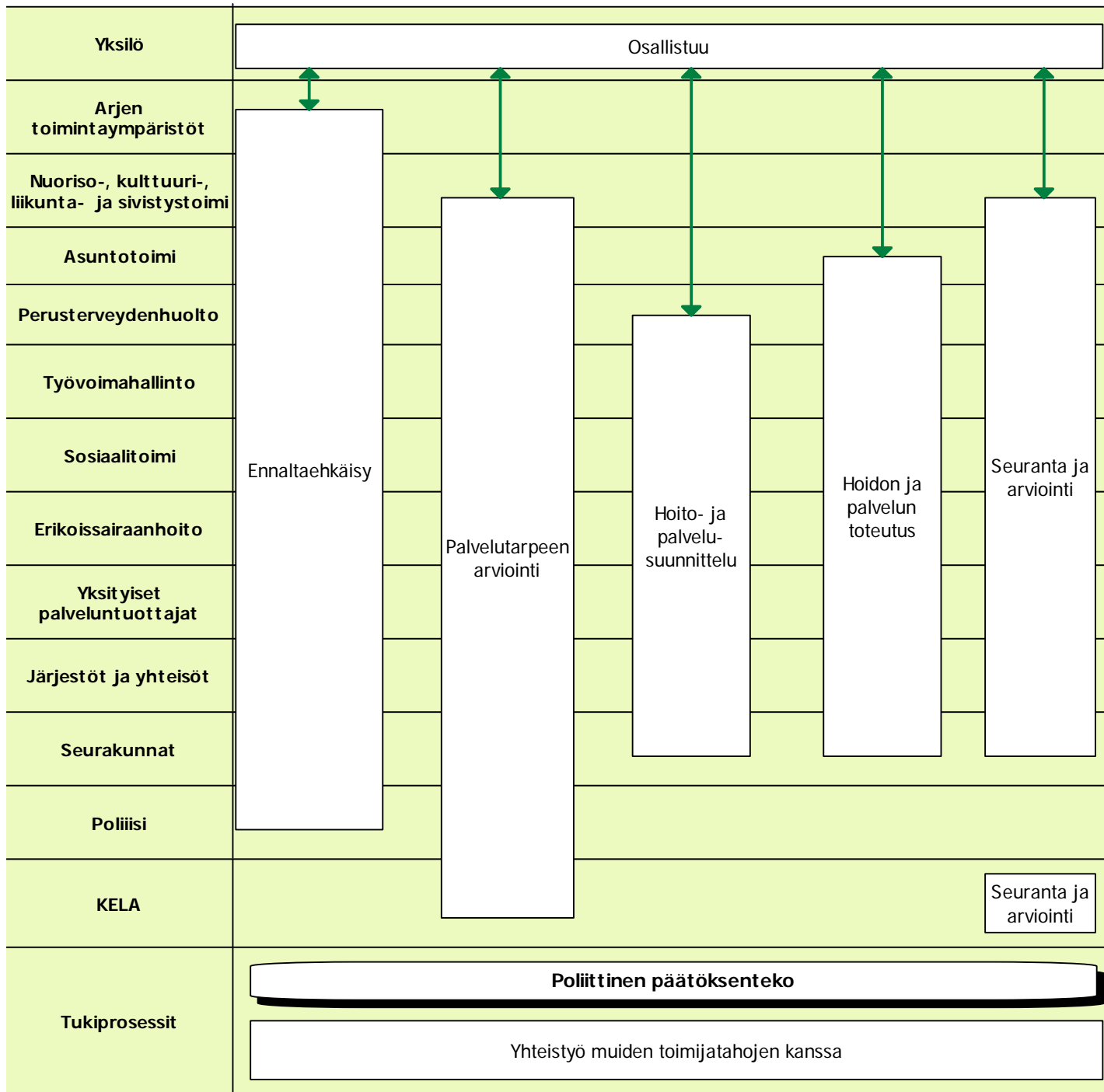

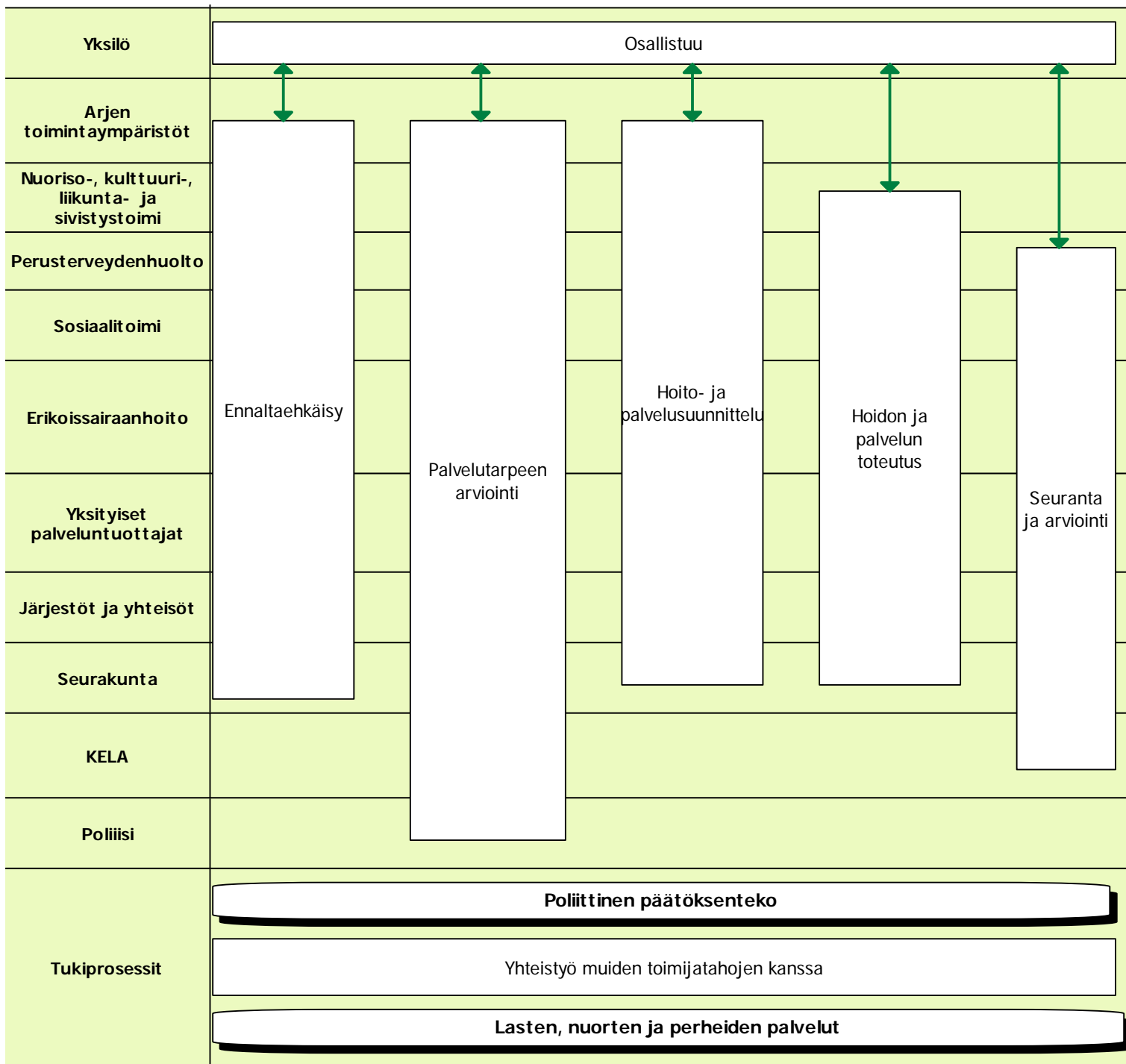

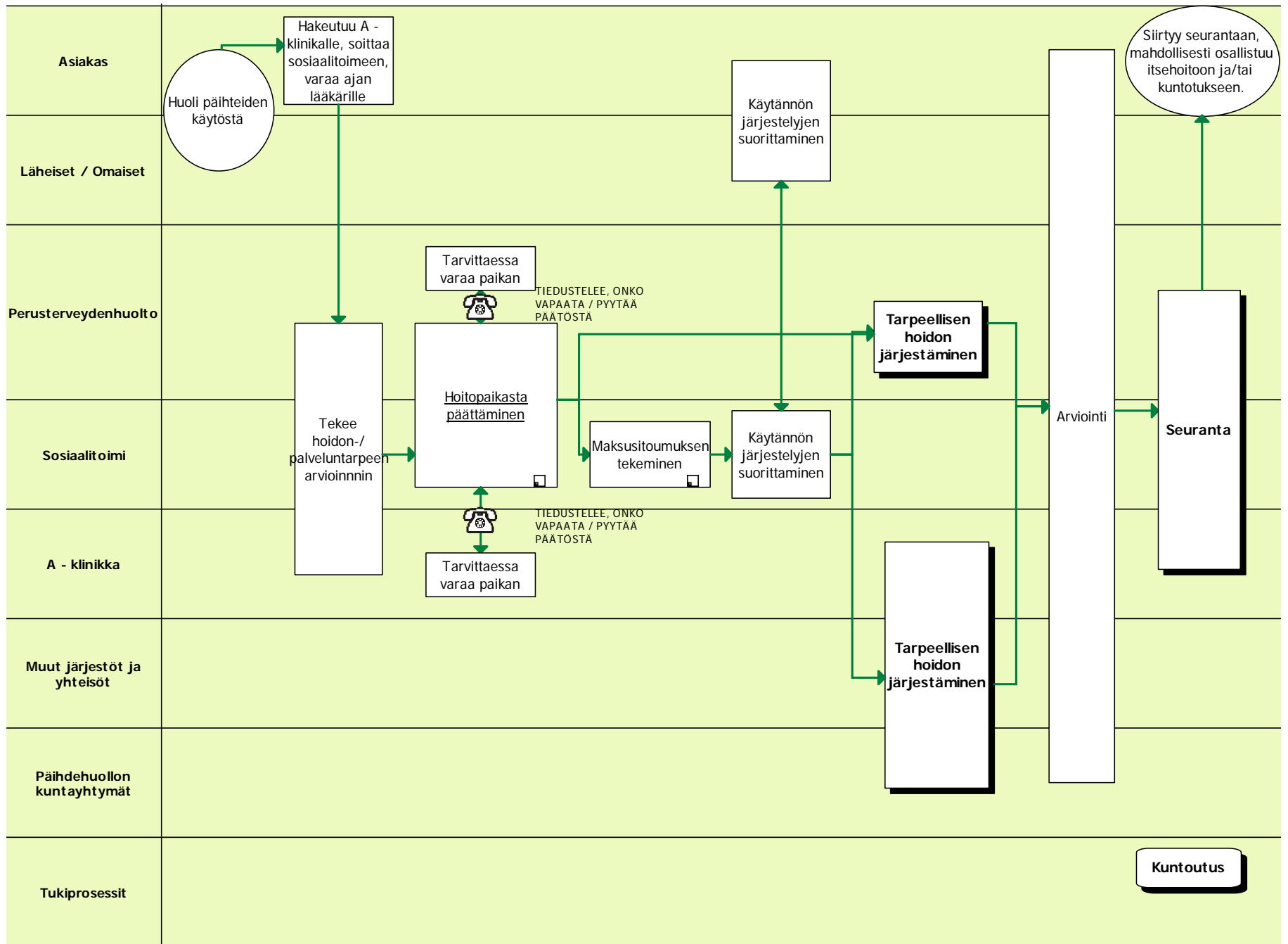

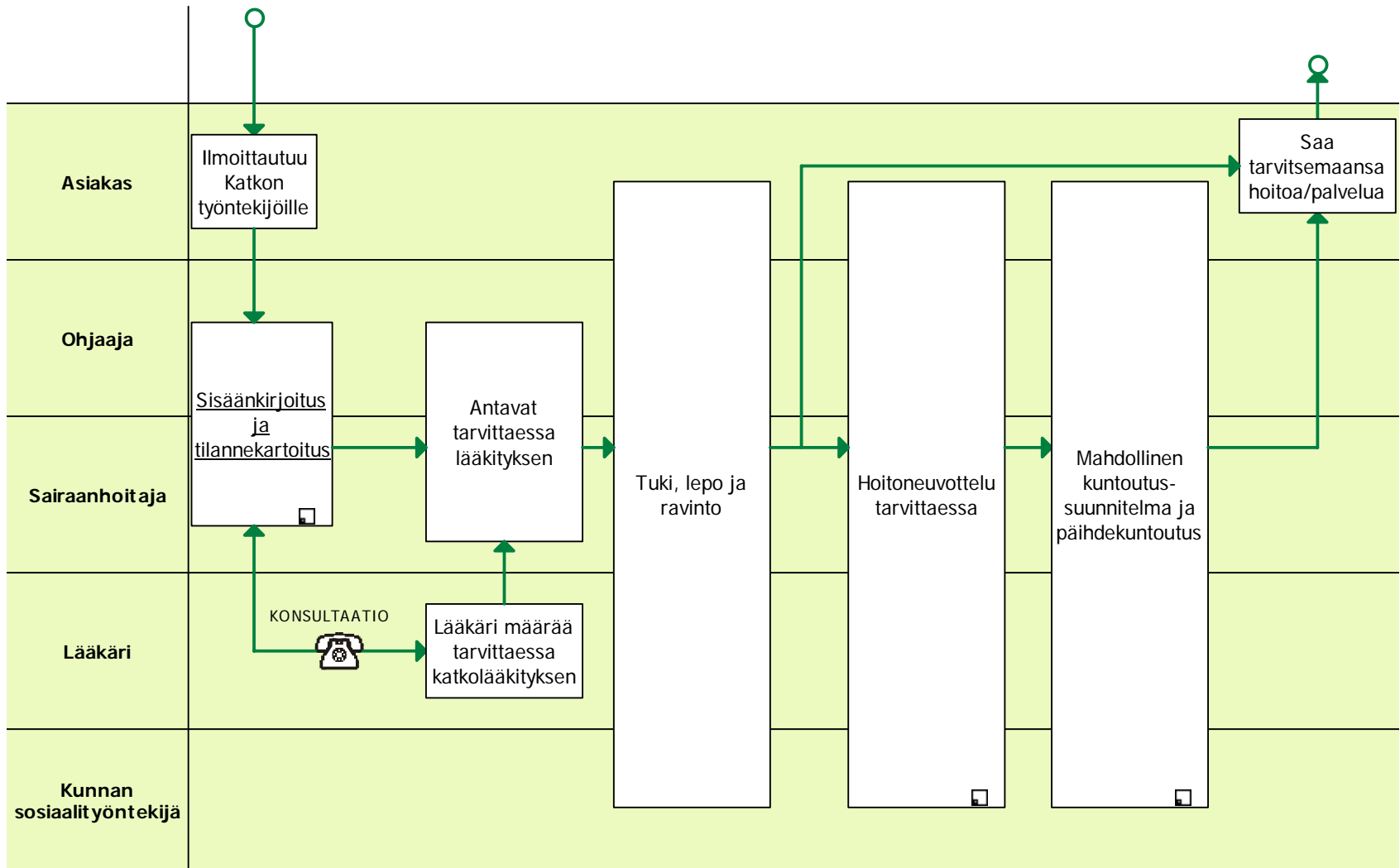

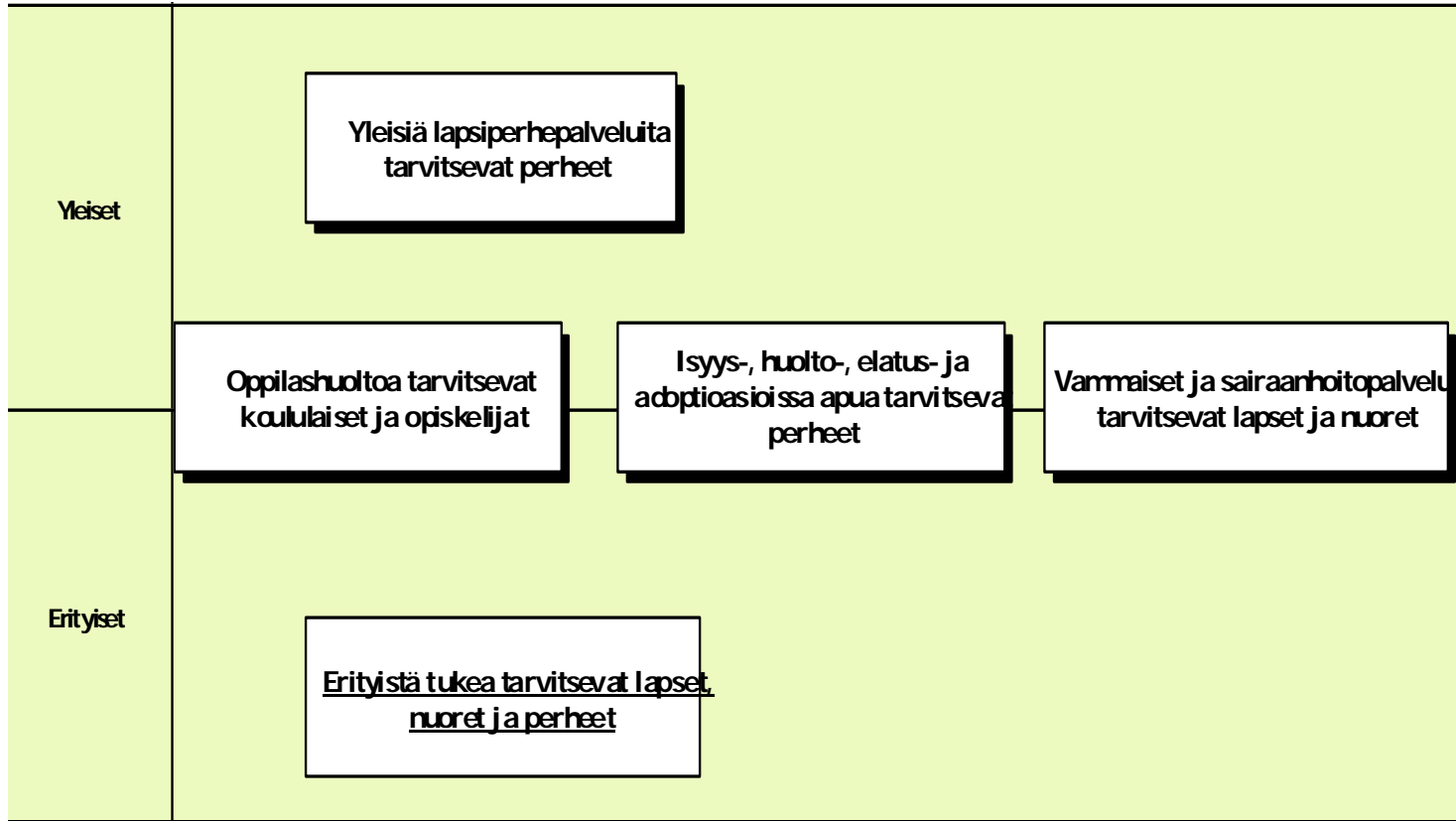

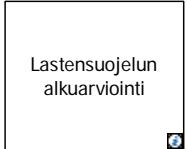
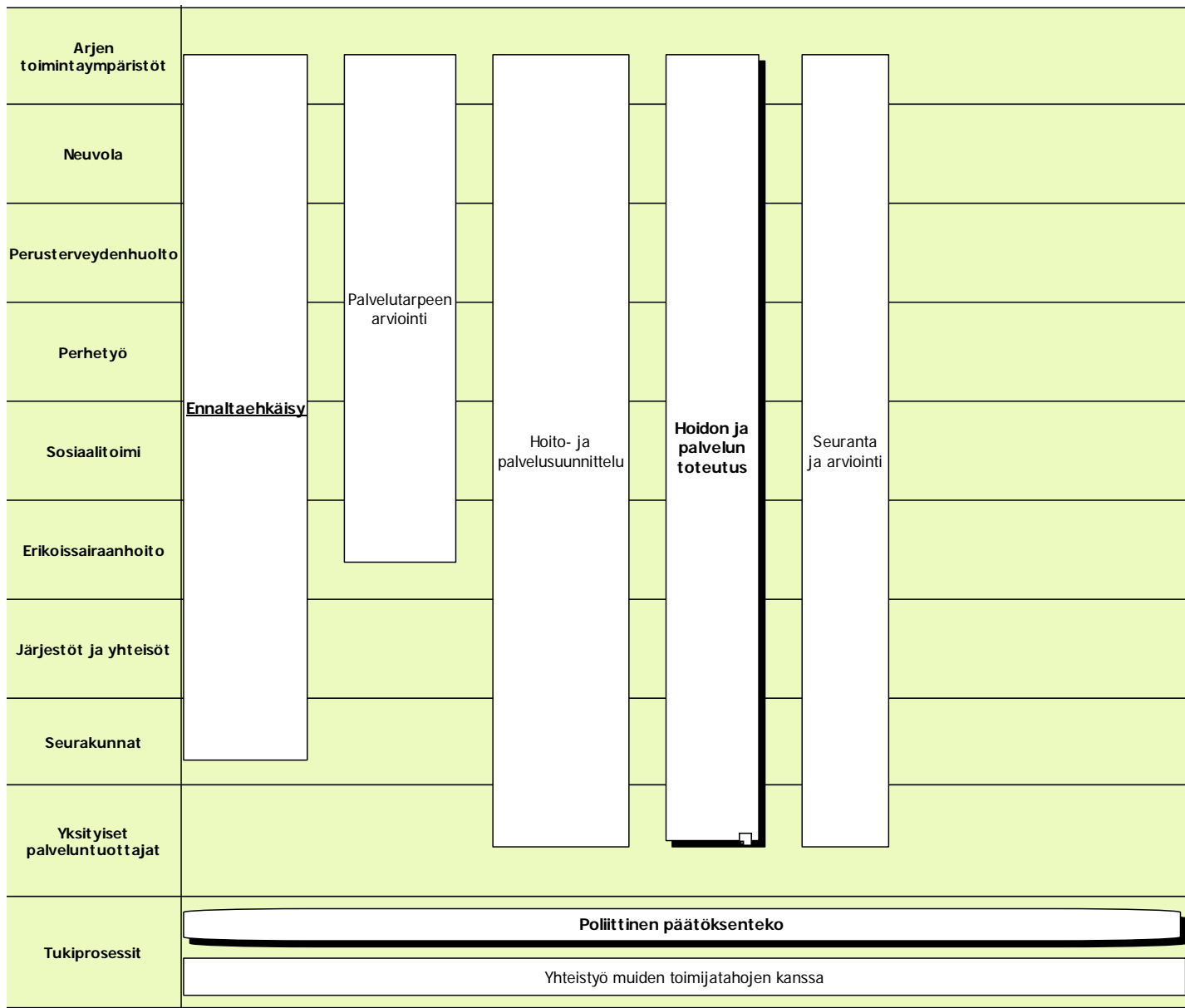

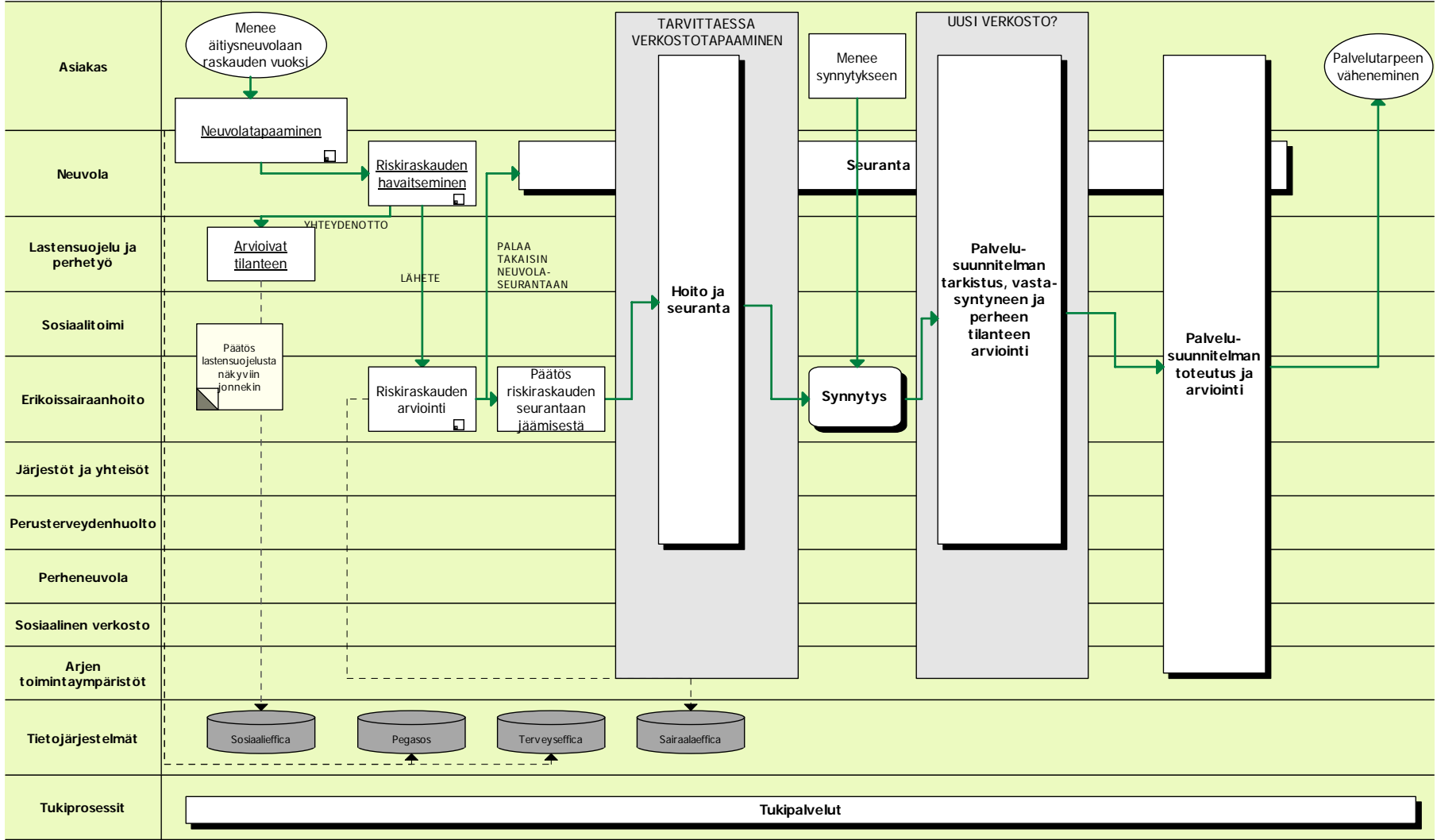

Palvelukokonaisuudet

Muistihäiriöiset vanhukset

**Laitosasumiseen liittyviä
palveluita tarvitsevat
vanhukset**

**Kotona asumisen ja toimintakyvyn
tukemista tarvitsevat vanhukset**

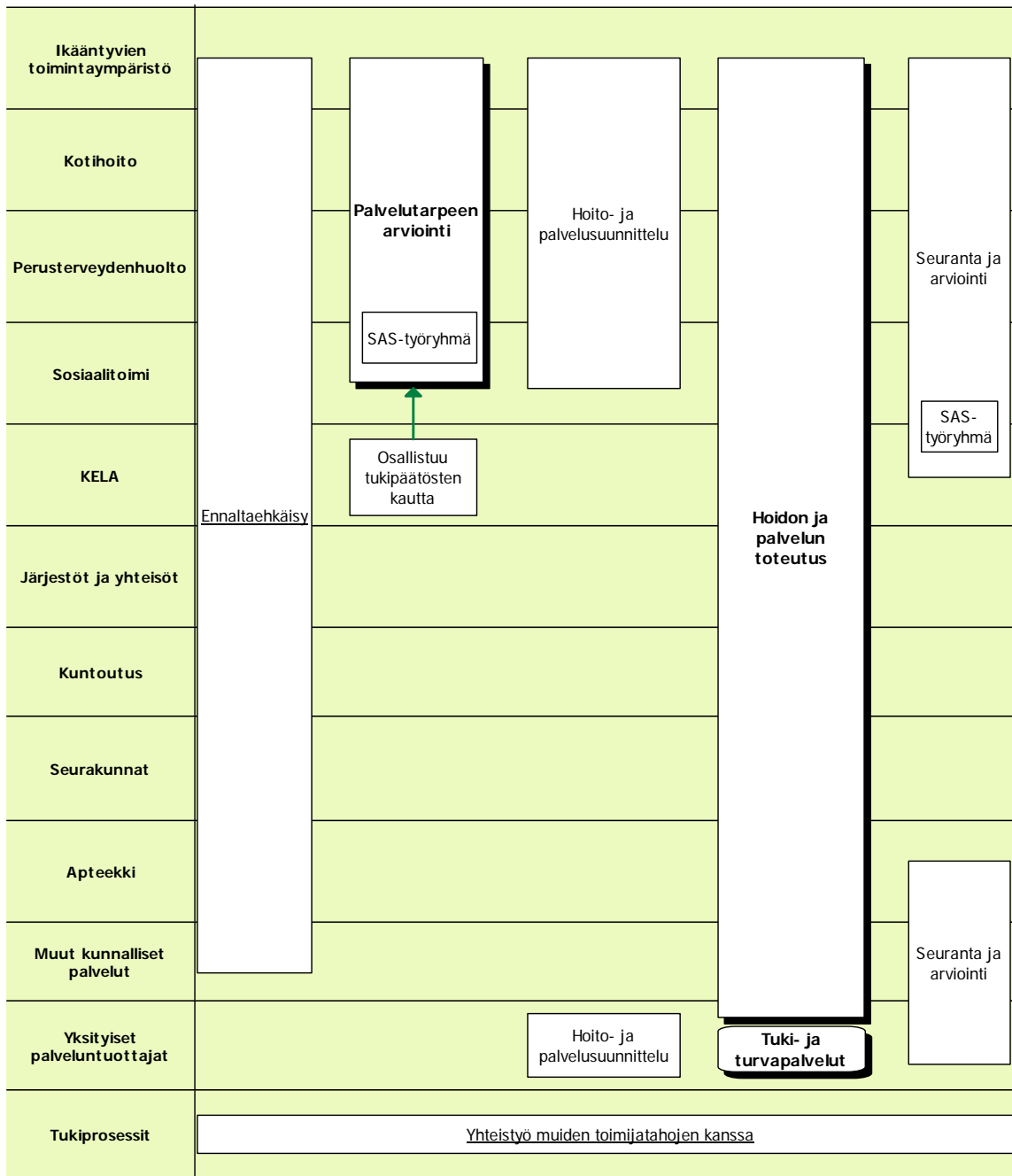

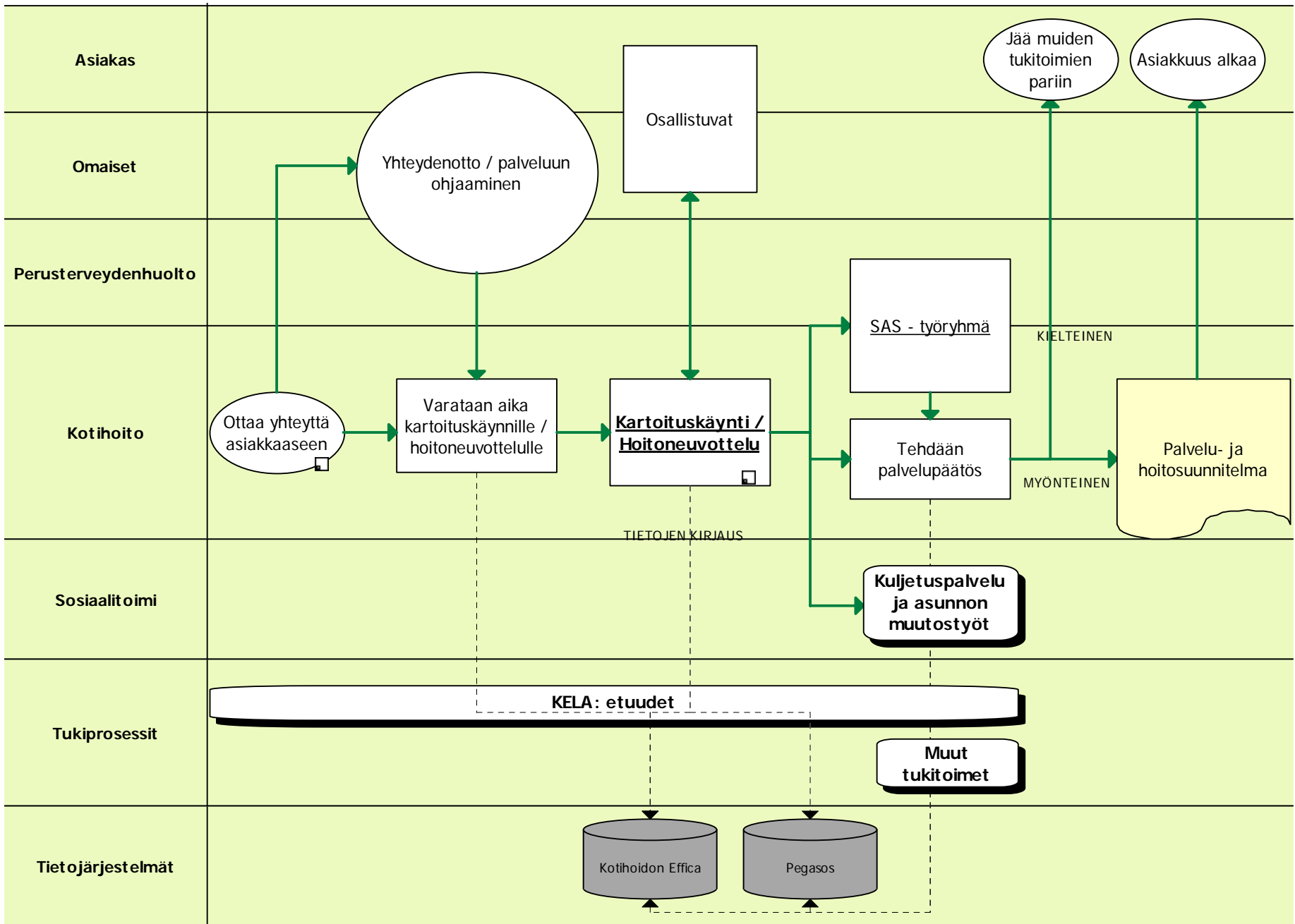

**Kotihoidon rooli erikoissairaanhoidosta
kotiuduttaessa**

